

PatternMaker Software™

Babies' Garment Collection

Designer: Leena Lahteenmaki

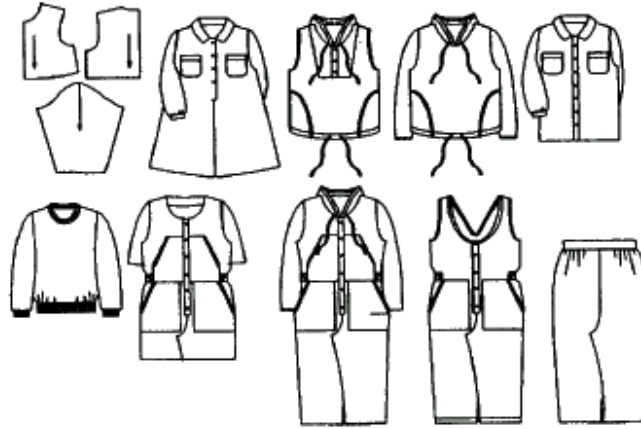

INTRODUCTION

Welcome to the PatternMaker Babies' Garment Collection! These macros are designed with standard sizes for babies 62-98 cm (2' to 3'2") tall. If your baby's size does not fall within this range, you will have to use custom (actual) measurements instead of the standard ones, but the macros will still work. When your baby grows too big for these patterns, use PatternMaker's children's macro set.

Although it is not necessary to sew a fitting shell for baby clothes, a basic bodice pattern is included in this collection, which you can use to design your own garments.

WHAT ARE MACROS?

Each PatternMaker macro is a small computer program which is run by PatternMaker. You will be asked to make some style choices and type in your measurements. The program then does some calculations and draws a garment pattern. These are complete patterns, ready to cut out and sew. All of these macros have been tested in commercial use for a wide range of sizes and measurements. Once you make a pattern from a macro, you can change it to create your own individual garment.

Most of these garments require an intermediate or advanced level of sewing skill. If you do not already know how to assemble a garment, sew buttonholes, etc., you will need to refer to a general sewing text as well as these instructions.

PatternMaker has many patternmaking features, and the macros are a good way to start learning about them. Use this booklet to get started making patterns. Practice the tutorials to see how some of the PatternMaker commands are used, and read the User's Manual to learn the details.

OVERVIEW

Here's what you need to do to make your new set of garments with PatternMaker:

- **Run the macro for the garment you want.** PatternMaker will ask you for some measurements, which you will type in. Then it will draw the pattern. If you already have a pattern on the screen, the new items will be added to it. You can now use all of PatternMaker's various features to modify your pattern, if you wish. Or you can just print it out and sew it.

- **Add seam allowances.** The macros in this collection do not automatically draw seam allowances for the patterns, so if you want a printed seam allowance, use the OFFSET command to add it. Suggested amounts are ¼ inch (.5 cm) for collars, (½ inch (1 cm) for most seams and 1½ inch (3 cm) for trouser hems.
- **Arrange for printing.** You may need to use the MOVE and ROTATE commands to arrange the pieces for the most efficient printing.
- **Print your pattern.** If you have a small desktop printer, you will need to tape the pages together. The pages will be marked to make it easy to assemble them.
- **Cut out and sew your new garment.** This booklet gives you most of the sewing instructions you need, but always rely on your common sense. We hope you enjoy your new clothes!

MEASUREMENTS

It's not usually necessary to take measurements for baby clothes. If custom measurements are required or desired, use the measuring techniques described on the Children's Measuring Chart, included in this package.

ABOUT EASE

We do not include an ease chart for the babies' garments because it should not be necessary to adjust ease for babies' clothing. Baby clothes are deliberately designed for a loose fit. These Baby macros also have additional ease added in the seat to allow room for diapers. Some macros give you a choice of "Normal" or "Wide" ease, and some select the ease automatically. Wide eases are for garments with very loose fit, or for outer garments that are to be worn over other clothes. Enter the correct measurements, and the macro will add the ease.

RUNNING A MACRO

When you first start the PatternMaker program, you will see a blank drawing area. To run the macros, select the MACRO command from the File menu, or click on the icon which has the word MAC. (Users of PatternMaker Basic should select OPEN from the File menu, or click the OPEN icon.)

A dialog box will ask you to select a file. Each macro is a separate file in your PatternMaker directory. Descriptions of each macro are given later in this book. The file names in this collection are:

- BBIBSUIT
- BBODICE
- BDRESS
- BPANTS
- BPANTS2
- BPLAYSUIT
- BSHIRT
- BSUIT
- BSWEATER
- BTSHIRT
- BVEST

Click on the name of the file, and then click "OK". It may take a few seconds for PatternMaker to load the macro.

First, the macro asks you to choose a standard size based on your baby's height. You have to choose a size even if you plan to type in custom measurements. Select the choice that is closest to your subject's height.

The next dialog box shows you the standard measurements for that height. Some of the macros have two dialog boxes for measurements. The illustration at the right shows one of the measurements dialog boxes. To accept these measurements, just click the "OK" button. If you want to use custom measurements instead, enter the correct numbers and then click "OK".

The screenshot shows a dialog box titled "Babies' playsuit" with a close button (X) in the top right corner. It contains several input fields for measurements:

Bust circ	18	Waist circ	18.5
Hip circ	20	Neck circ	9.75
Shoulder length	2.25	Back width	8.25
Sleeve length	7.75	Wrist circ	4
Back length	7.25		

At the bottom of the dialog box, there are two buttons: "OK" with a green checkmark icon and "Cancel" with a red X icon.

Remember to use decimal numbers:

1/8	-----	.125
1/4	-----	.25
3/8	-----	.375
1/2	-----	.5
5/8	-----	.625
3/4	-----	.75
7/8	-----	.875

Be careful to enter the right numbers in the right spaces. When you are ready, click "OK" or press the <Enter> key.

You may have to wait a minute for the macro to run, especially if you don't have a fast computer. You will know the macro is done when the hourglass cursor changes back to an arrow and the word **Command:** appears on the prompt line.

IF YOU CANNOT SEE THE PATTERN PIECES, OR IF YOU ONLY SEE PART OF THEM, PRESS THE <END> KEY TO VIEW ALL THE PIECES IN THE DRAWING.

Look at your macro

The macro will draw your new pattern in the drawing area. If you already have a drawing, the new items will be added to the existing ones. To zoom out and see the entire pattern, press the <END> key. To zoom in, use <F2> or <F3>. Use the arrow keys to move up, down, left, and right. (See the PAN and ZOOM commands in the Help file.)

ARRANGE YOUR PATTERN

Now, you can use the PatternMaker editing features to make changes to your pattern. PatternMaker has tools to make almost any alteration. Some simple changes you may want to make before you print are:

- Erasing an object (ERASE command)
- Moving an object (MOVE command)
- Rotating an object 90 or 180 degrees (ROTATE command)
- Label your pieces (TEXT command)

Refer to the User's Manual or the Help file for detailed instructions on these commands.

IF YOU MAKE A MISTAKE

If you make a mistake in one of the above operations, you can use the UNDO command to undo your last change. The Undo icon looks like a letter "U." If you make a really big mistake, you can use the New command (on the File menu) to start all over. Luckily, this isn't hard to do.

READ THE MANUAL

Here are some other commands you'll want to learn before long. Look them up in the User's Manual or the on-line Help system.

- MOVE VERTEX to adjust shapes
- SET LINE to draw dotted lines
- COLOR to draw in different colors
- GROUP to keep groups of things together
- DIM and SET/MEASURE DISTANCE to check measurements
- POLY to draw your own objects
- COPY and MIRROR to copy objects
- LAYER to hide things from view

Note: These commands are available only in the Home Version and higher.

PRINT YOUR PATTERN

Before you print out your pattern, you should use the MOVE command to arrange the pieces in the most efficient way you can, to save paper. The pieces aren't arranged for you, because the best arrangement will depend on your measurements and the size of the printer you have. If possible, arrange the pieces to fit within a rectangle no wider than your printer's page size. Make sure you leave enough room for seam allowances, if you didn't already add them.

We assume you already have your printer set up and working. PatternMaker works with any Windows-driven printing or plotting device. If you have a printer with tractor-feed paper, print in Landscape mode to make the pages connect in the correct order.

See "Printing a pattern" in the Help file for details about the various Print commands, and "Assembling a printed pattern" for instructions on putting the pages together.

BABIES' GARMENT MACRO DESCRIPTIONS:

BBODICE.MAC

Fitting shell, includes 2-3/8" (6 cm) ease at waist and 3-1/8" (8 cm) ease at chest. Use this to develop your own patterns. It is rarely necessary to make fitting muslins for baby clothes.

BBIBSUIT.MAC

Bib overall with large patch pockets at hip and chest. If you want to add elastic at the waist, sew a "tube" for it at the bottom end of the facing as marked on the pattern. Front piece includes a button placket. If you prefer a zipper, attach it to center front seam with no button extension.

BDRESS.MAC

Loose, full-length dress with convertible collar and a button placket in front. Macro draws long sleeves and patch pockets on chest. Sew short sleeves instead if desired.

BPANTS.MAC

Trousers with front and hip pockets, waistband and zipper. Has one soft pleat in front and a dart in back.

BPANTS2.MAC

All-purpose pants with elastic waist instead of waistband. Has hip pockets.

BPLAYSUI.MAC

Playsuit – a short-legged, short-sleeved jumpsuit with large patch pockets at hip and chest. If you want to add elastic at waist, sew a "tube" for it at the bottom end of the facing. Use the similar tube in BBIBSUIT.MAC as a guide when adding this to the pattern. Front piece includes a button placket. If you prefer a zipper, attach it to center front seam with no button extension.

BSHIRT.MAC

A baby-sized version of a man's dress shirt with convertible collar. Has long sleeves, but you can make them short if desired.

BSUIT.MAC

Like playsuit, but with long legs and sleeves. Chest pocket has different styling.

BSWEATER.MAC

A loose, boxy sweater/sweatshirt with drawstrings at hood and hem and button placket on front piece. If you prefer a zipper, attach it to center front seam with no button extension. You can sew this pattern in knit or non-knit fabric.

BTSHIRT.MAC

Long-sleeved T-shirt. Sew short sleeves if you wish. Separate (ribbing) pieces for sleeve cuff, collar, and waistband. You may need to change the length of these pieces before cutting. The proper length depends on how elastic the ribbing fabric is.

BVEST.MAC

This is a sleeveless hooded sweater/sweatshirt. It has a yoke with button placket in front and drawstrings at hood and hem. If you prefer a zipper to the button placket given by the macro, attach it to center front seam with no button extension. Vest can be worn over a T-shirt or shirt. You can also use this pattern to create a girl's yoked summer dress by adding length to the hem and designing the neck opening according to your wishes.

SEWING INSTRUCTIONS

FOLLOW THESE STEPS FOR WORRY-FREE CONSTRUCTION

GENERAL INSTRUCTIONS

- When you buy your fabric, ask how much it will shrink when washed. In all cases, when the fabric is washable and when you are not sure that the fabric won't shrink, it is safe to wash and iron it before cutting. Don't forget to preshrink lining as well.
- Cut pattern pieces on folded fabric, right side of the fabric folded inwards. Make the necessary marks on the fabric with chalk or pencil. If the fabric is plaid, striped or checkered, align the hem lines at the same point on the repeating pattern. For sleeves, the repeating pattern should match where the bottom of the armhole and bottom of sleeve cap meet. Vertical centerline of sleeve should be placed at a vertical stripe or at center of a plaid square. Jacket, blouse and dress front center should be placed the same way.
- Transfer notch marks from your pattern to the fabric by cutting snips (depth 1/4 inch/5 mm) into seam allowances. When joining garment pieces, place corresponding notch marks in the two pieces together.
- Cut and iron interfacings onto under collars, facings, waist bands, button extensions and sleeve cuffs.
- If you sew a patch pocket and don't line it, fasten interfacing to it also. Woven interfacing gives the best results. The macros draw all facings on top of the garment pieces, with dashed lines. If you want to print them apart from the pieces, use the MOVE command to move them before printing.
- Cut lining along with garment patterns without space for facings (but remember to add seam

allowances) and hem seam allowances. Do not cut lining for collars. Lining fabric usually is not as elastic as garment fabric, so cut it with about 1/8 inch (0.3 cm) wider seam allowances than for the garment pieces.

- Use the longest possible machine stitches for basting. It is quick and the stitches can easily be removed.
- The macros make the patterns without seam allowances. If you want to add seam allowances, use PatternMaker's Draw/Offset and Draw/Seam Allowances commands (see the Help file for details). The suggested seam widths are 3/8 inch (1 cm) for most seams, and 1 - 1/2 inch (4 cm) for hems and sleeve ends without cuffs. When you are sewing your first garment with PatternMaker patterns, add extra seam allowance so that you can make corrections to the garment if it should be necessary.
- You will get the best result if you always press seams and darts as you sew. First iron seams or darts flat without turning them to either direction. Then press them towards center, side seam towards front. Two-piece sleeve seams are both pressed towards shoulder mark. Use a steam iron. If you press seams from right side of the fabric, use pressing cloth if necessary.
- Edgestitching gives a well-finished look to garment, but only if it is straight and even. Long stitches of 1/4 inch (4-5 mm) look best in edgestitching. Sew edgestitching only after you have ironed the seam.

HOW TO FASTEN WAISTBAND to pants

1. Iron interfacing to wrong side of waistband. Overlock edges. Fold waistband lengthwise, right sides out, and press. Sew one horizontal edge of waistband to garment, right sides together, (1). Space for button and buttonhole extension extends beyond center front mark at each end of the band. Garment's waist should always be slightly larger than waistband. Easestitch garment waist to fit waistband.
2. Fold waistband lengthwise, right side inside, and sew across one end (buttonhole end) (2). Cut corners and turn waistband right side out. Press seam allowance upward (raw edges of seam will be inside waistband when finished).
3. Fold seam allowance of waistband in about 2 inches (5 cm) from each end but leave rest of waistband seam allowance flat (flat makes it easier to catch when sewing through from the right side, but leaves the raw edge on the wrong side of the skirt instead of tucked into the waistband). Stitch on right side of garment along first stitch line (4) called "stitch in the ditch." Sew button hole and fasten button.

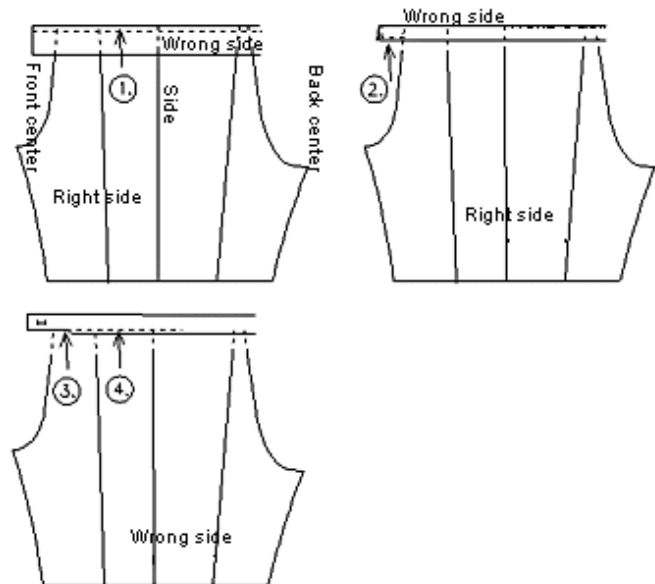

HOW TO SEW ZIPPER to pants

1. Sew seam to the point where zipper begins and mark zipper's full length with basting. Press the seam open. Remove basting stitches.
2. Mark front (or back) centerline with basting (1). Fold one seam allowance of zipper placket at

about $\frac{1}{4}$ " (0.5 cm) distance from front (or back) centerline (2). Sew one zipper edge under the extended seam allowance (3).

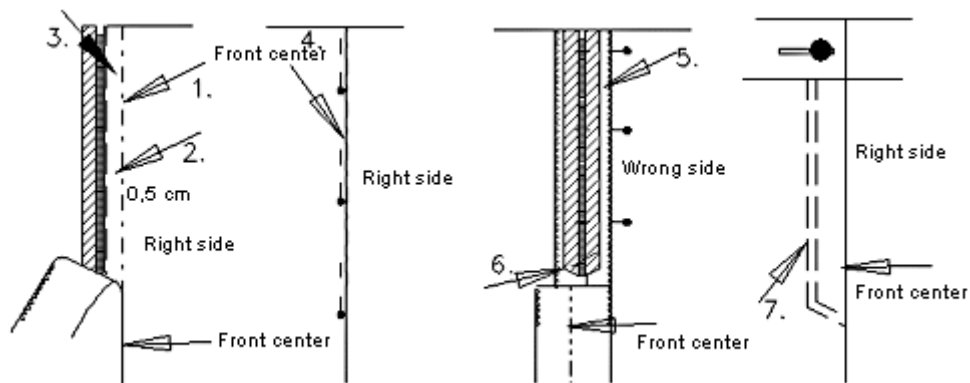

- Close zipper placket temporarily with pins on right side of garment (4). On wrong side pin other zipper edge flat on seam allowance (5). Make certain that the zipper is straight and lies flat at an even distance from edges of seam allowance. Remove pins from right side. Sew from wrong side through all thicknesses, across bottom and up the pinned edge of zipper near zipper teeth.

If you want to, you can sew a second row of stitches one presser foot's distance from the first one (7). If you are making jeans or other pants that need to be very strong, strengthen bottom of zipper placket with tight zigzag (bartack) on right side.

For an unnoticeable zipper placket:

Sew zipper directly onto garment seam, placing zipper upside down on a basted seam on wrong side of garment. The distance between the seam and the zipper stitching is the width of the presser foot. Basting is removed after sewing. This kind of a zipper is good for a dress back seam and is also widely used in skirts.

HOW TO SEW AND ATTACH COLLARS

- For the collar, cut 2 pieces of fabric and 1 piece of interfacing. The under collar piece is on the inside, hidden by the upper piece, when the garment is completed.

- Overlock button placket and front center edges. Sew front center seam from hem to where button placket begins (1). Fold button placket inwards along fold line and sew along bottom (2) and top (3) ends from fold line to front center. Cut seam allowances diagonally at point where seam ends, so that button placket can be turned right side out.

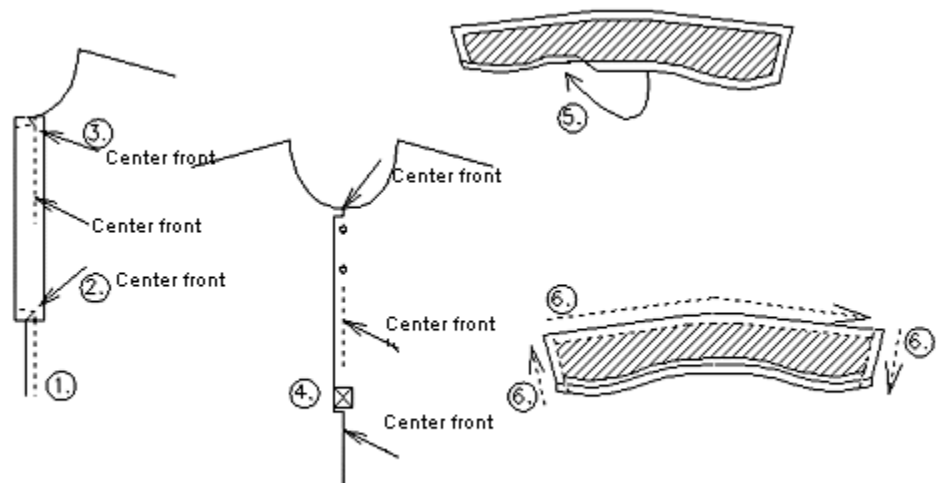

- Turn button placket right side out (4). Place button plackets' front center marks on top of each other and sew a box at bottom end of placket. Stitch through all layers of fabric.

4. Iron interfacing to under collar. Turn bottom seam allowance of under collar inside and baste (5).
5. Place collar pieces with right sides together and sew along edges (6). Trim seam allowances and cut corners. Turn right side out.
6. Sew raw edge of upper collar to shell's neck from front center to front center, right sides together. Press seam allowance upwards and pin basted edge of under collar on top of previous seam. Sew. If you have difficulties in sewing a neat collar, sew basted edge of under collar by hand.

HOW TO SEW AND ATTACH A HOOD

1. The hood piece in the pattern makes one half of the hood. Cut 4 pieces, 2 of garment fabric and 2 of lining fabric. The lining pieces can also be of same or similar fabric, if desired. Sew both outer pieces together, right sides together (1). Do the same with the lining pieces. Snip the seam allowance along the curved section at back of hood at intervals of about 3/4 inch or 2 cm (2).
2. The openings for the drawstring are sewn like small buttonholes at right side of hood 3/4 inch (2 cm) from front edge and 1 1/2 inches (4 cm) from bottom edge (3). To strengthen button holes, iron interfacing to wrong side of fabric before sewing button holes.
3. Turn neck seam allowance of hood lining inwards and baste (4). Place lining and hood right sides together and sew along front edges (5). Turn hood right side out.
4. Sew hood to neck of shell, right sides together, from center front to center front. Press seam upwards and pin the basted edge of hood lining onto seam. Sew near edge.
5. Sew a 3/4 inch (2 cm) wide tube for strings at front edge (6).

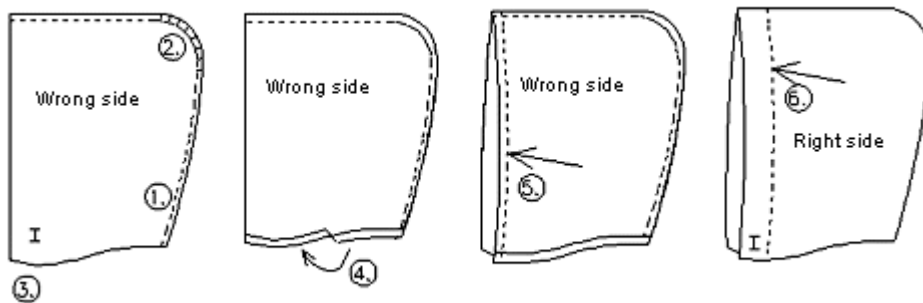

HOW TO SEW AND ATTACH SLEEVE CUFFS

1. Fold in seam allowance of one long edge of sleeve cuff and baste (1).

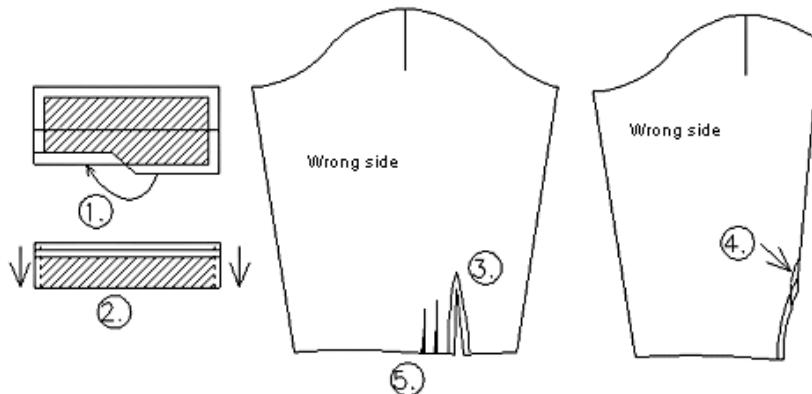

2. Fold cuffs horizontally in two, right sides inside, and sew along ends (2). Note that seam allowance of one edge has been folded in, but the other is unfolded, so the edges don't meet. Cut seam allowance diagonally at corners and turn cuffs right side out.
3. Cut slits at ends of sleeves and overlock edges. Turn seam allowances inside and edgestitch on right side (3). Fold slit with right side inside and sew across bottom of slit (4).
4. Fold ease of sleeve ends into soft pleats near split (5). Sew raw edges of cuffs to sleeve ends with right side of cuff against wrong side of sleeve. Turn seam allowance inside cuffs and press. Pin basted edge of cuff onto previous seam and edgestitch from right side.
5. Sew buttonholes and attach buttons to cuffs.

HOW TO SEW SIDE POCKETS

1. Cut 4 pieces for pockets, 2 for pocket back pieces and 2 for pocket linings.
2. Place pocket lining piece on the shell, right sides together. Sew along pocket mouth (1). Cut seam allowance diagonally (2).
3. Turn pocket lining to inside and topstitch pocket mouth (3). Place pocket back piece under pocket lining piece edges matching (4). Sew and overlock along round and bottom edges. Pocket back piece is attached to side seam when sides are sewn. Be careful not to sew pocket mouth.

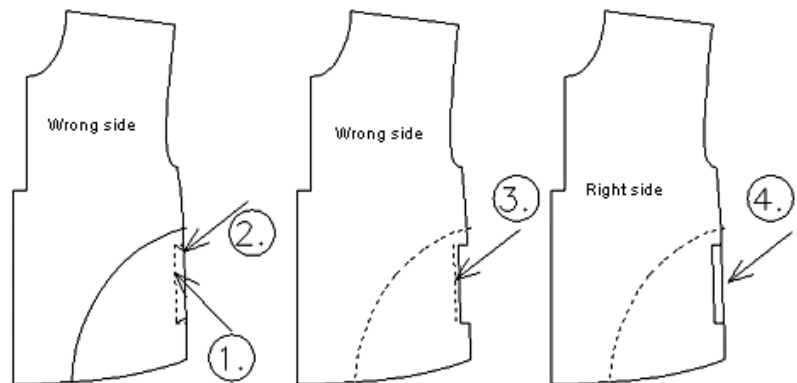

SEWING A T-SHIRT (BTSHIRT.MAC)

1. Check that waist, neck and cuff ribbings are of suitable length. The correct length depends on how elastic the ribbing fabric is.
2. Sew and overlock shoulder seams with right sides together (1). Join sleeves to shell, right sides together (2). Overlock. Sew sleeve seam and side seam continuously from sleeve cuff to shell hem, right sides together (3). Overlock.
3. Sew ends of waist ribbing together, to form a ring. Fold lengthwise in two, wrong side inside. Divide the

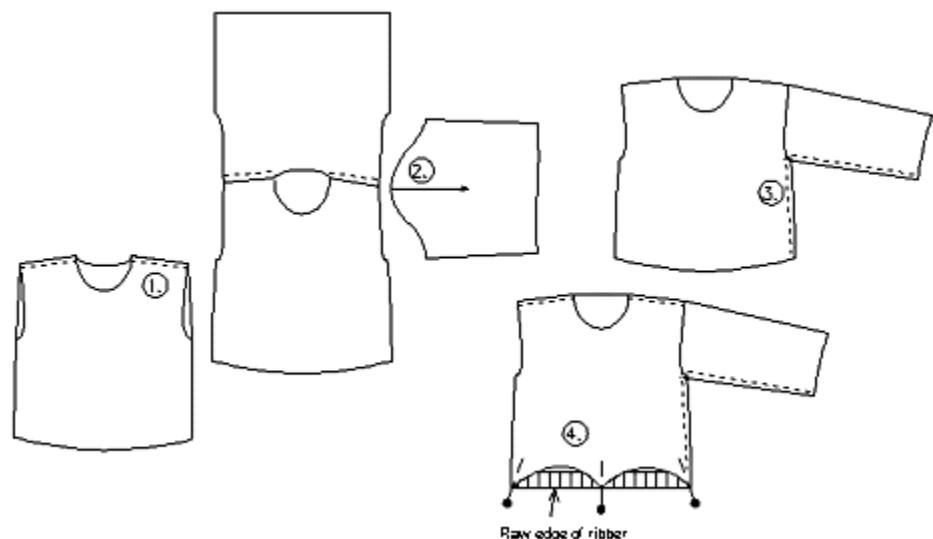

circumference of the ring into four equal parts and mark them with pins through both layers on the cut edges. Do the same with the bottom of the shell. Then pin together corresponding marks and stitch (4), stretching the ribbing to fit. Shell should be inside out now, and the ribbing is inside it. Sew and overlock. Attach neck and cuff ribbings in the same way.

SEWING A DRESS (BDRESS.MAC)

- The dress illustrated is constructed with a placket in front. Variations can use buttons or a back closure (zipper or buttons). If you want to put a collar on the dress, use general instructions and leave out the neck facings.
- Sew front center seam from hemline to where the button placket begins (1). Fold button placket right side inwards and sew bottom edge from fold to center front (2). Cut seam allowances diagonally here (2).
- Iron interfacing to pocket pieces (3). Turn seam allowances inwards and baste. Topstitch top of pocket. Sew pockets to their places on front pieces simultaneously edgestitching them. The exact location of the pockets is a styling decision for you to make.
- Sew and overlock shoulder seams (4) and side seams (5), right sides together. Easestitch sleeve cap with normal seam allowance (6)
- Sew and overlock sleeve seams. Turn shell wrong side out and sleeves right side out. Place sleeves inside shell (7) and match sleeve shoulder marks with shell's shoulder. Pull the ends of the edgestitching threads to gather ease in. Sew and overlock.
- Sew front and back neck facing pieces together at the shoulder (8). Place facing on neck of shell, right sides together. Fold front button placket, right side inwards, under the facing (9). Sew placket to facing. Snip seam allowances at 3/4 inch (2 cm) intervals and turn facing inwards. Edgestitch or stitch through seam allowances only near seam.
- Sew and attach sleeve cuffs according to General Instructions above. Fold hem allowance twice and sew. Sew buttonholes and fasten buttons to front center.

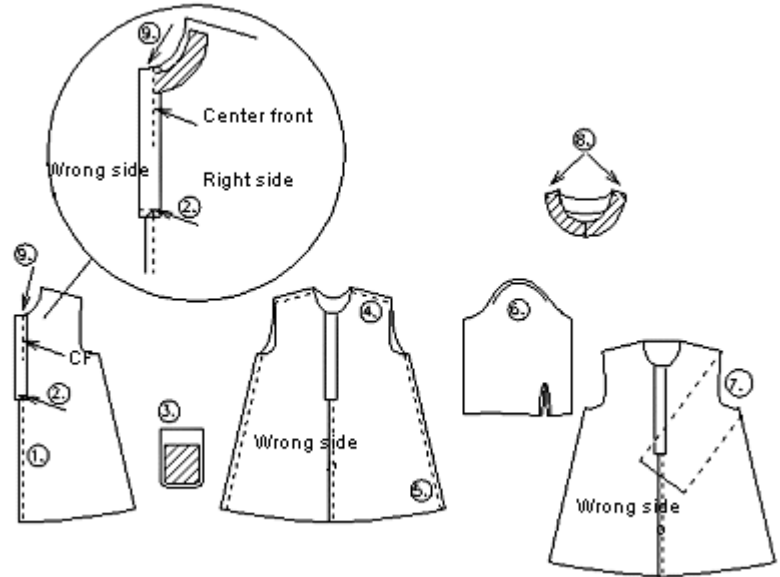

SEWING A SHIRT (BSHIRT.MAC)

1. Fold seam allowance at front edges inwards 1/2 inch (1 cm) and baste (1). Fold again with right side of fabric inside, along button extension fold line. Stitch button extension across top edge from fold to center front (2). Cut seam allowances diagonally (2). Turn button extension out and sew along folded seam allowance edge on wrong side of fabric.

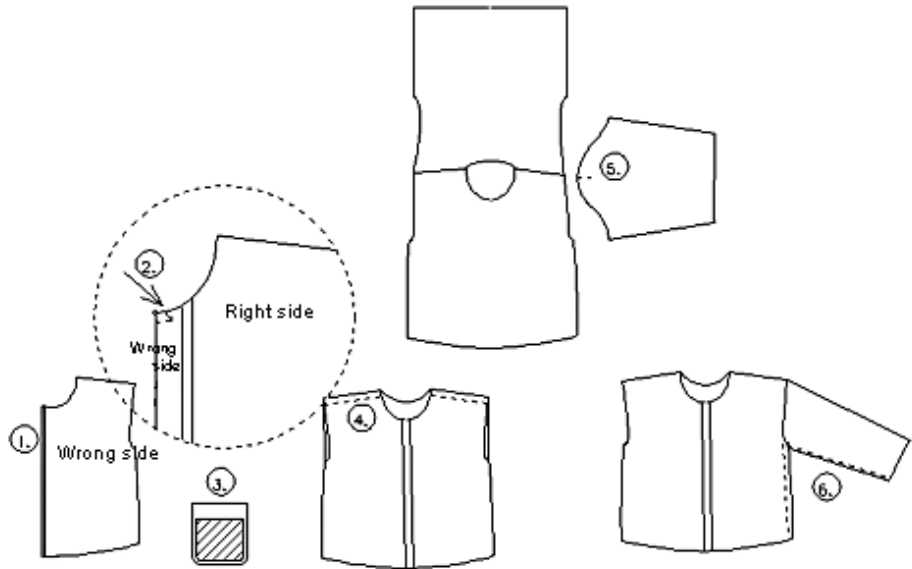

2. Iron interfacing to pocket (3). Fold seam allowances inwards and topstitch pocket mouth. Sew pocket in place, edgestitching it simultaneously.
3. Sew and overlock shoulder seams, right sides together (4). Join sleeves to shell, right sides together (5). Overlock. Sew sleeve seam and side seam continuously from sleeve cuff to shell hem (6). Overlock.
4. Use General Instructions (above) to attach collar and sleeve cuffs. Fold hem allowance twice and sew. Sew buttonholes and fasten buttons to front center.

SEWING PANTS (BPANTS.MAC and BPANTS2.MAC)

1. Sew center seam at crotch from leg to where zipper placket begins (1). Attach zipper according to General Instructions above (2). Place pocket lining on top of pants pocket corner, right sides together, and sew (3). Snip seam allowance at intervals of about 3/4 in (2 cm). Turn facing inside and topstitch pocket mouth twice (4).

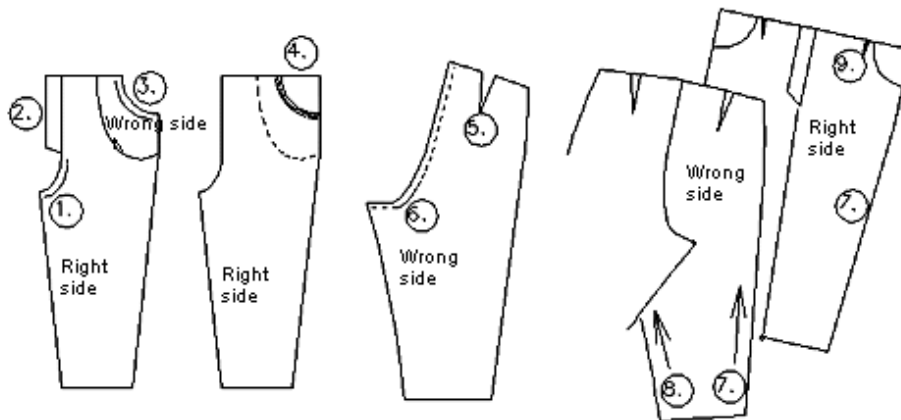

2. Sew back waist darts (5). Sew center back seam, with elastic stitches if possible (6). Place front and back pants on top of each other, right sides together, and sew along side seams (7) and leg seams continuously from cuff to cuff (8). Fold front pleats soft and pin (9).
3. Attach waist band according to General Instructions above.

4. Fold cuff seam allowances twice and sew. Sew button and buttonhole on waistband.

PANTS VARIATIONS:

For Pants version 2, (bpants2.mac), omit the zipper and back darts. Sew ends of waistband together to form a ring. Overlock one long edge and sew other edge to pants waist, right sides together. Press seam allowance upwards. Fold waist band horizontally in two and sew along previous seam line. Leave a hole for inserting elastic. After inserting elastic, close hole.

SEWING A SWEATER (BSWEATER.MAC)

(see illustration for T-shirt)

1. Sew side pockets to front pieces according to separate pocket instructions above. For the body of the sweater, follow the instructions for T-shirt but do not attach ribbings.
2. Sew and attach hood according to General Instructions above. Make small buttonholes in front piece, on both sides of center front and 2½" (6 cm) from bottom edge. These are the holes for the drawstring. Strengthen buttonholes by ironing interfacing to wrong side of fabric, then sew buttonholes. Fold hem allowance inwards 1½" (4 cm) and sew on right side with twin needle to form a tube for drawstring.
3. Fold sleeve ends inwards and sew on right side with twin needle.

SEWING A VEST WITH HOOD (BVEST.MAC)

1. Overlock all edges of yoke pieces for shoulder and neck seams. Do the same with the front piece edges to which yoke is to be joined. Fold button plackets of front yoke inwards along fold line. Fold front piece's yoke seam allowances inwards and baste (cut seam allowance diagonally at corners to allow it to fold). To strengthen the corner to be cut, sew line of stitches around corners at width of seam allowance from edge. Place yoke pieces on top of each other so that their center fronts match (=button plackets on top of each other). Then place front piece on top of the yoke. Baste and sew yoke to front piece, simultaneously edgestitching it.
2. Sew and overlock shoulder and side seams of shell and armscye facings. Place facings onto armscyees of shell, right sides together. Sew and overlock. Snip the seam allowances at ¼" (2 cm) intervals. Turn facings inwards and edgestitch. Hand sew facings with small stitches to shell's shoulder and side seams.
3. Sew and attach hood according to General Instructions above. Make small buttonholes in front piece, on both sides of center front and 2½" (6 cm) from bottom edge. These are the holes for the drawstring. Strengthen buttonholes by ironing interfacing to wrong side of fabric, then sew buttonholes. Fold hem allowance inwards 1½" (4 cm) and sew on right side with double needle to form a tube for drawstring.

SEWING BIBSUIT, OVERALL, AND PLAYSUIT (BBIBSUIT.MAC, BSUIT.MAC, and BPLAYSUIT.MAC)

1. Sew front center seam from leg seam to where button placket begins (1). Fold button placket right side inwards and sew bottom edge from fold to center front (2). Cut seam allowance diagonally here (3). Turn out. Place button plackets on top of each other, center fronts matching, and sew over bottom edge through all layers of fabric.

2. Iron interfacing to pocket pieces (4). Turn seam allowances inwards and baste. Topstitch pocket mouths. Sew pockets to their places on front pieces, simultaneously edgestitching them.

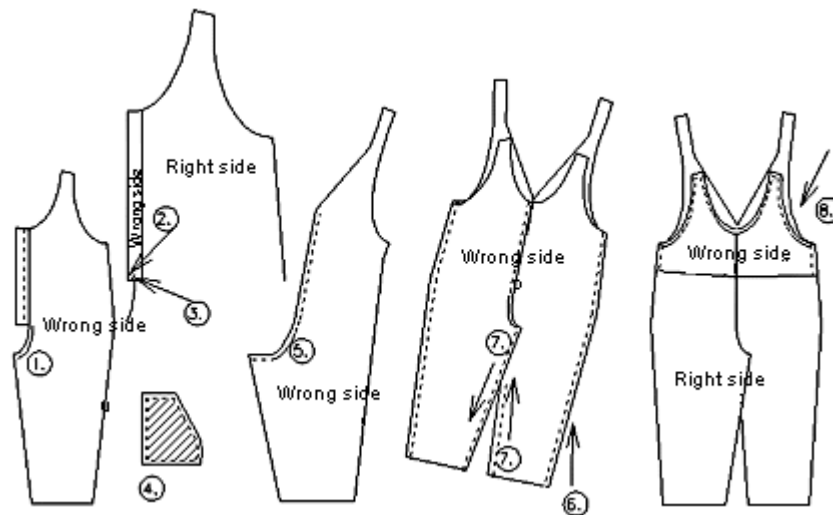

3. Sew back center seam, with elastic stitches if possible (5).
4. Place front and back pieces on top of each other, right sides together. Sew side seams (6). Sew leg seam continuously from cuff to cuff (7).
5. Sew side seams of facings. Fold button placket along folding line, right sides together. Place facings on it on overall's neck, right sides together. Sew along top edges continuously from center front, around shoulder straps and along armholes to back shoulder straps etc. (8).
6. Snip the seam allowance along the curved section at intervals of about $\frac{3}{4}$ " or 2 cm. Cut corners of seam allowance. Turn facings and shoulder strips inside and edgestitch. Sew buttonholes to back shoulder straps and buttons to front shoulder straps. Fold leg ends two times and sew.
7. For patterns with hoods, attach hood according to General Instructions above. Attach sleeves according to instructions given for T-shirt.

PatternMaker Software

Measuring for Children's Macros

You will need:

- three pieces of 1" wide elastic
- a measuring tape.

The subject should stand straight but relaxed while being measured. You will receive the best results if the measurements are taken over underwear.

Place the elastic bands around the chest, waist and hip. Search carefully for the correct places of these elastic bands. Keep these elastic bands on their places during the whole measuring process. Hip elastic is fastened on the level where hip circumference is maximum. Examine whether it is on the buttocks (7-8 inches/18-20 cm below the waist) or on top of the thighs (10-12 inches/25-30 cm below the waist). Vertical measurements are taken from the bottoms of the bands.

It is important to use the elastic bands throughout all measuring. Don't remove the elastic before all necessary measurements have been taken.

Except for pants' cuff circumference and skirt/dress length, all measurements are body measurements. DO NOT ADD ANY EASE to the measurements. The program does it for you.

DO NOT TIGHTEN MEASURING TAPE.

Please, refer to the picture related to this measuring form.

You can use either centimeters or inches. Make your measurements accurate to the nearest ¼" or ½ cm.

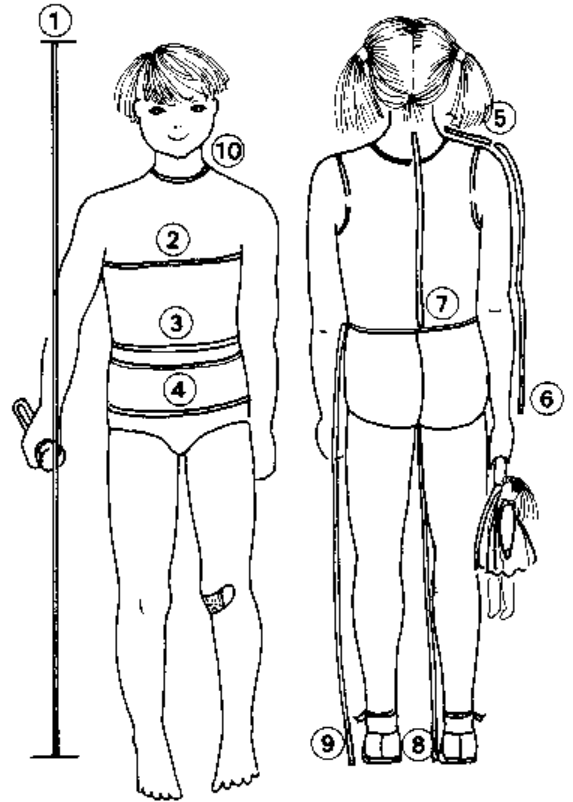

Name: _____

Date: _____

1	Body height: Measure the full height of the subject.	
2	Bust/Chest Circumference: Marked with elastic. Measure around the fullest part of the chest, keeping the tape high at the back	
3	Waist Circumference: Measure waist at the elastic tape	
4	Hip Circumference: Measured over the largest part of the subject's bottom/thighs (at elastic)	
5	Shoulder length: Measure from bottom of neck to shoulder tip. Shoulder tip is found when you raise the arm to horizontal position and feel where there is hollow/pit between shoulder and arm bones. Hold child's arm horizontal, if necessary, to find this point.	
6	Overarm: Arm length from shoulder tip (as described above) to wrist. Bend arm slightly and measure over outside of elbow.	
7	Back Length: Measure from center of back neck to lower edge of waist elastic	
8	Inside seam: Measure from crotch to desired cuff length on an existing pair of pants.	
9	Outside seam: Measure from waist over the outside curvature of the hip to the desired cuff length.	
10	Neck Circumference: Measure around lowest part of neck, at the base.	